

# 2804 Hybrid Packet Broker

## Multi-functional Bypass Packet Broker

The Niagara 2804 hybrid packet broker uniquely combines multi-purpose bypass functionality with a fully featured network packet broker. The 2804 hybrid packet broker supports 16 ports of 1/10Gb, plus additional eight 1/10Gb I/O packet broker ports. The 16 ports of 1/10Gb come in configuration-segments of four ports each. This flexibility lets you configure the 2804 with up to four 1/10Gb multi-purpose bypass segments, or with up to sixteen 1/10Gb I/O packet broker ports, or any combination of bypass segments and packet broker ports.

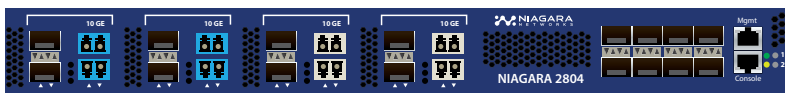

Figure 1: 2804 front panel with sixteen 1/10Gb ports configured in 4-port segments (2\*multimode, 2\*single mode). Additional eight I/O packet broker ports (on RHS)

## Multifunctional Network Packet Brokers Segments

Each 4-port segment comprises two network and two appliance ports. The network ports offer direct single mode (SM) or multimode (MM) connectivity. The appliance ports utilize SFP+, giving the flexibility to connect appliances (tools) using 1Gb or 10Gb, whether SM, MM or copper.

Each of the segments' four ports can be configured as fully featured I/O packet broker ports. Dual rate, integrated 1/10Gb transceivers on the network ports connect the network traffic to a common, non-blocking backpanel switching fabric layer. Because all of the 2804 ports connect to this common non-blocking switch fabric backplane, inputs from any port can be used as outputs in any other port.

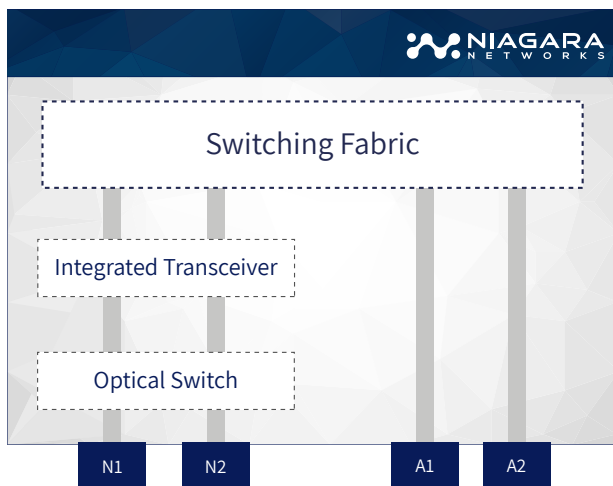

Figure 2: multi-purpose 4-port segment. Appliance ports can serve the hybrid functionality of fully-featured I/O packet broker ports.

## Product Highlights

### High Density:

Sixteen 1/10Gb ports configured in four, 4-port segments plus additional eight I/O packet broker ports

### Multi-functional Segments

Network ports support SX/SR and LX/LR

- Bypass for inline deployments
- Active Tap split mode
- Active Tap aggregate mode

### Management:

- Robust command line interface (CLI)
- User-friendly, web-based user interface
- REST API for third-party integration and support
- Managed by Niagara Visibility Controller (NVC)

### Form Factor:

- 1U Rackmount
- Dual field-replaceable power supply



**Fabric Flow:** FabricFlow technology exposes network packet broker features enabling the user to map traffic from one segment to any other segment (or from one port to any other port).

The fully featured network packet broker functionality includes:

- Aggregate traffic to single port
- Replicate traffic to multiple ports
- Sophisticated filtering—L2-L4, User Defined Byte (UDB)
- Tunnel and VLAN support
- Flexible multi-load balancing schemes
- User-configurable packet heartbeat (ms resolution)
- Ingress and egress filters

# Network Bypass Technology

The two network ports in each 4-port segment have additional special capabilities. They can be used to configure the network ports to function as an active Tap or as a bypass.

When configured as a bypass our signature BypassP<sup>2</sup> Technology offer double-protection. A fail-safe optical relay on network ports, and user-configurable heartbeat-generated packets on appliance ports.

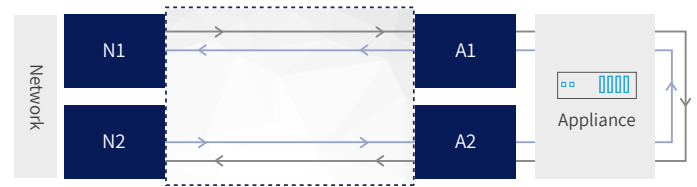

Figure 3: Inline deployment

In Bypass/Inline deployment, traffic from one side of the network is forwarded to the inline appliance, and through the inline appliance to the other side of the network. This is the common network deployment for inline security devices such as firewalls and intrusion detection systems. Any two appliance ports from the network's port segment or from any other 4-port segments can participate in this configuration since all ports are connected to a common non-blocking switch fabric backplane.

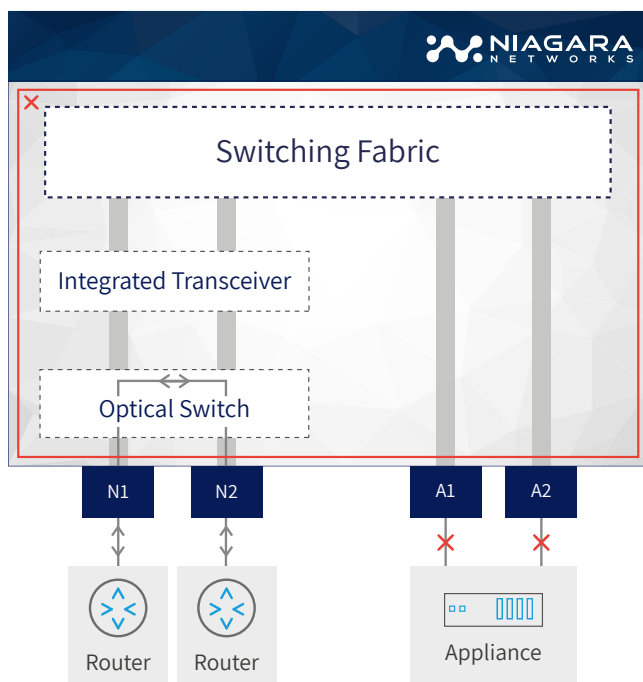

Figure 4: Power Failure Mode

**Failsafe protection** - protecting network traffic flow in the event of Network Packet Broker (NPB) failure. When power fails, as depicted in figure 4, the optical-relays ensure that the network flow continues uninterrupted. The optical relays can be configured fail open or fail close to meet specific deployment needs. An optical switch mechanism is the most reliable method for connecting inline devices to your network, while ensuring uninterrupted network services under all conditions.

**Heartbeat protection** - protecting network traffic flow in case of appliance failures. The NPB transmits a user-configurable heartbeat on the appliance ports as depicted in figure 5. In the event of an appliance malfunction (such as a software crash, system failure or loss of power depicted in figure 6), the failure is detected, and the NPB bypasses the traffic intended for the inline appliance to the network ports, allowing it to continue to flow through the network link. This feature also enables the network appliances to be removed and replaced without network downtime. Once the system is back up, or the power is restored to the appliance, it is detected by the NPB's heartbeat mechanism, and network traffic is seamlessly diverted back to the inline device, allowing it to resume its critical functions.

Niagara's heartbeat mechanism is an integrated configurable sub-second-rate mechanism that is available independently for each segment. The number of missed heartbeat packets before entering bypass mode is configurable, so too is the number of received heartbeats to determine that the appliance is back on-line. NPB heartbeat does not require additional drivers to be installed on connected appliances.

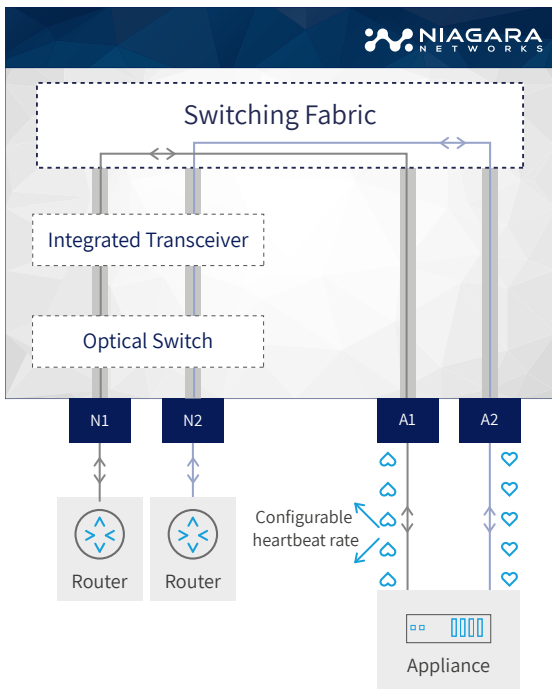

Figure 5: Normal inline Operation Mode

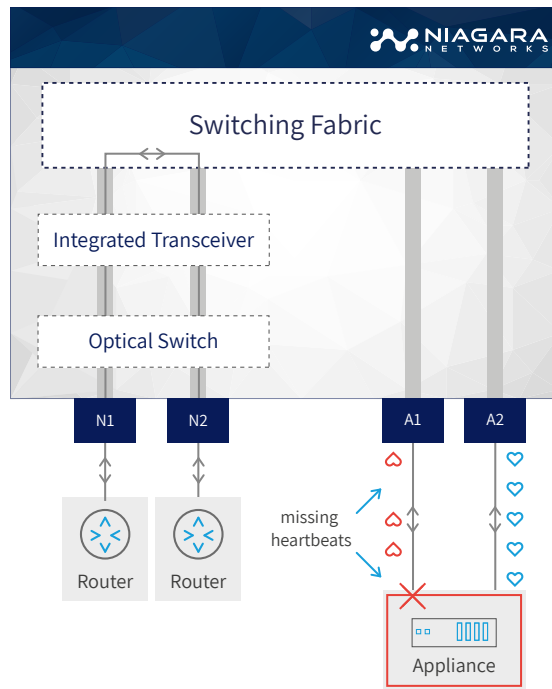

Figure 6: Appliance Failure Mode

Note: In the figures, the appliance ports (A1, A2) depicted belong to the same 4-port segment as the network ports (N1,N2). However, any two appliance ports from any other 4-port segments can participate in this configuration, since all ports are connected to a common non-blocking switch fabric backplane.

## Active Tap (aggregation)

In Active Tap, traffic on the network side is always maintained. Each appliance port receives a copy of the Rx from both sides of the network. This mode economizes on monitoring tool ports, if the total traffic throughput from both network sides is below that of the single appliance port. Any appliance port from any of the other 4-port segments can participate in this configuration, since all ports are connected to a common non-blocking switch fabric backplane.

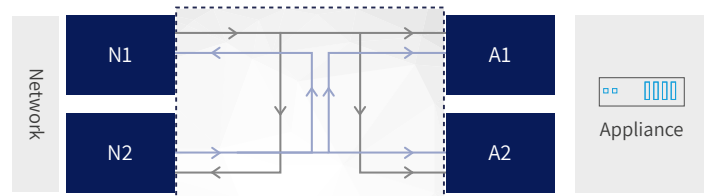

Figure 7: Active Tap (aggregation)

## Active Tap (split)

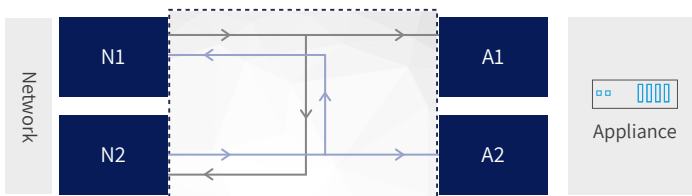

Figure 8: Active Tap (split)

In this Active Tap mode, traffic on the network side is always maintained. Each appliance port receives a copy of the Rx from one of the network ports. Any appliance port from any of the other 4-port segments can participate in this configuration since all ports are connected to a common non-blocking switch fabric backplane.

## Configuration Flexibility

The 2804 offers maximum flexibility with four hybrid segments per chassis. In addition to these four hybrid segments, the 2804 is configured with additional eight I/O packet broker ports.

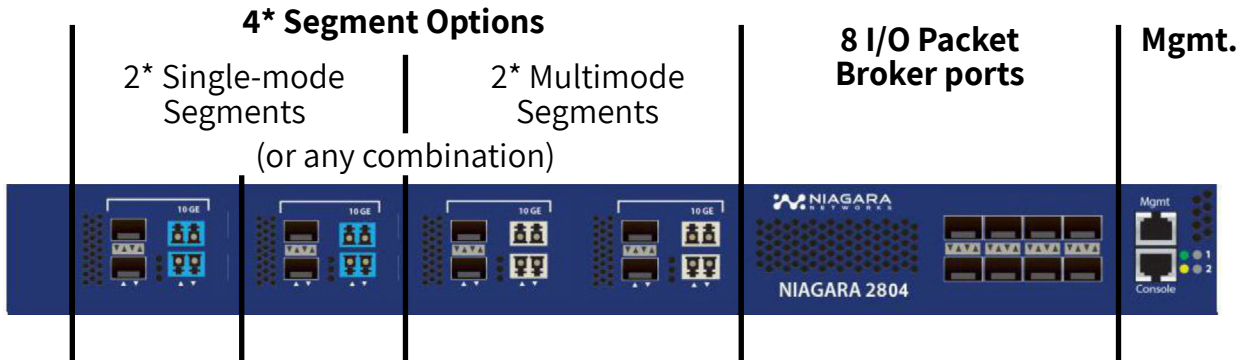

Figure 9: 2804 front panel depicting four segments, and eight additional I/O packet broker ports

## Integrated I/O Packet Broker ports

The eight I/O packet broker ports provide an additional, packet broker ports on top of those available as part of the bypass segment. The user can configure these ports as fully functional packet broker ports, as depicted in Figure 10. This provides the flexibility to have additional network tools in use cases where the bypass segments are used. If the power fails, the network traffic flow is maintained, however other packet broker ports lose their visibility.

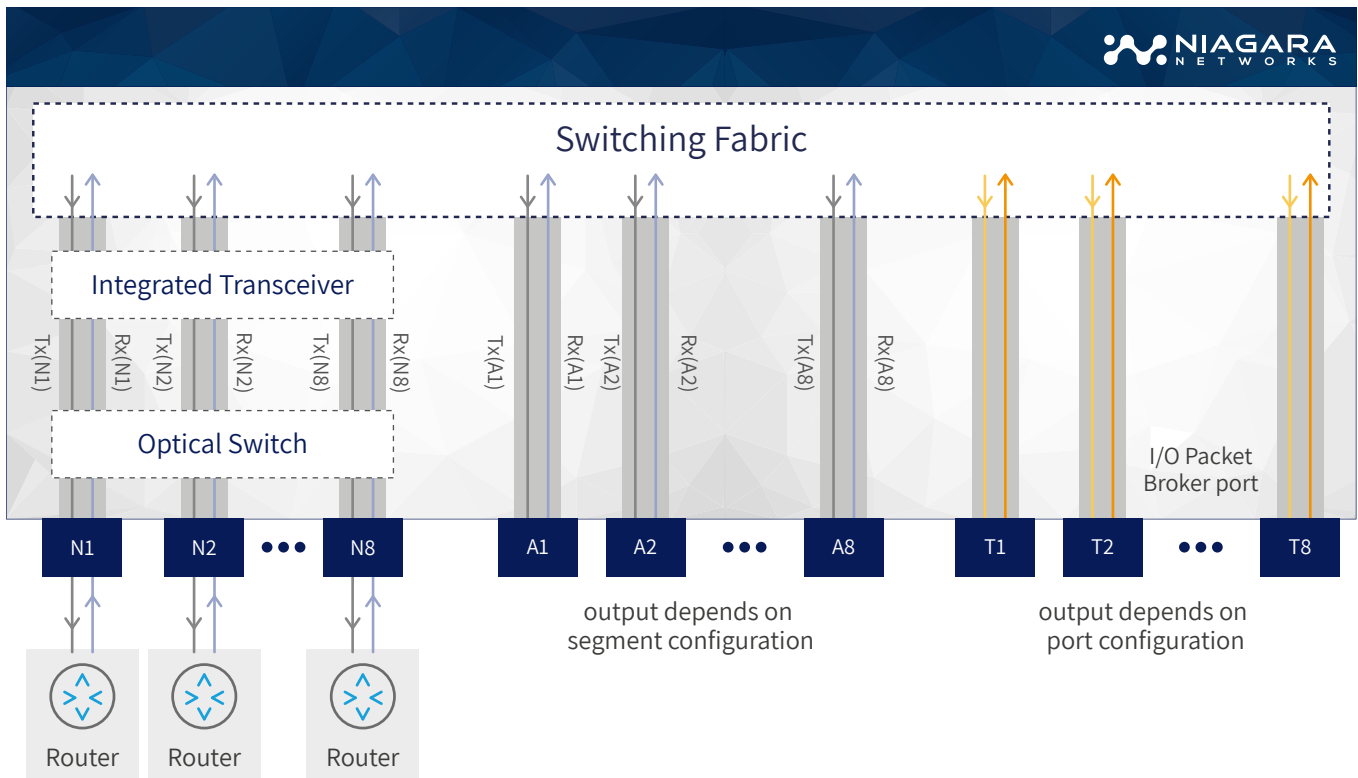

Figure 10: Integrated additional 8 I/O packet broker ports

## Specifications

Height	1.74 inches (44.20 mm)	Raw Power	191.47 Watts
Length	19.98 inches (507.49 mm)	Max Power	139.87 Watts
Width	17.25 inches (438.15 mm)	Max Current	1.40A @100V <sub>AC</sub> 3.89A @36V <sub>DC</sub>
Weight	19 lbs (8.62 kg)	Airflow	Front to back
Operating Temp	32 to 113 °F (0 to 45 °C)	AC	100-240V, 50/60 Hz., 5.29-2.2A
Operating Humidity	5 to 95%	DC	36-72V, 5A

## Emissions

FCC Part 15B, ICES 003, EN55032

## Immunity

EN55024

## Safety

UL/CSA 60950-1, EN 60950-1, IEC 60950-1  
CB Scheme with all country differences

## Certifications

North America (NRTL)  
European Union (EU)  
VCCI (Japan)

2014/35/EU Low Voltage Directive  
2014/30/EU EMC Directive  
2011/65/EU RoHS Directive  
2012/19/EU WEEE Directive

## Part Number

## Description

## Ordering Details

2804-MN-8ATP-yy	2804 Hybrid packet broker main. Supports four 4-port segments (selected separately). Two redundant power supply units and four fan units plus 8 I/O packet broker ports.	yy – user should specify preferred power supply option  AC – Dual AC redundant power supply DC – Dual DC redundant power supply
2800-SG-xx	4-port segment for 2804.	xx - users should specify network side fiber type: SR – multimode 50/125 SR5 – multimode 62.5/125 LR – singlemode Transceivers for appliance ports ordered separately
2804-MN8-4SR-xx	2804 hybrid packet broker AC chassis. Includes two power supply and four fan units, and four segment bypass with 1G/10G SR network. Appliance transceivers sold separately. Each segment includes 2 network ports and 2 appliance ports. Network port SR 50/125.	xx – user should specify preferred power supply option  AC – Dual AC redundant power supply DC – Dual DC redundant power supply
2804-MN8-4LR-xx	2804 hybrid packet broker AC chassis. Includes two power supply and four fan units, and four segment bypass with 1G/10G LR network. Appliance transceivers sold separately. Each segment includes 2 network ports and 2 appliance ports. Network port LR	xx – user should specify preferred power supply option  AC – Dual AC redundant power supply DC – Dual DC redundant power supply